

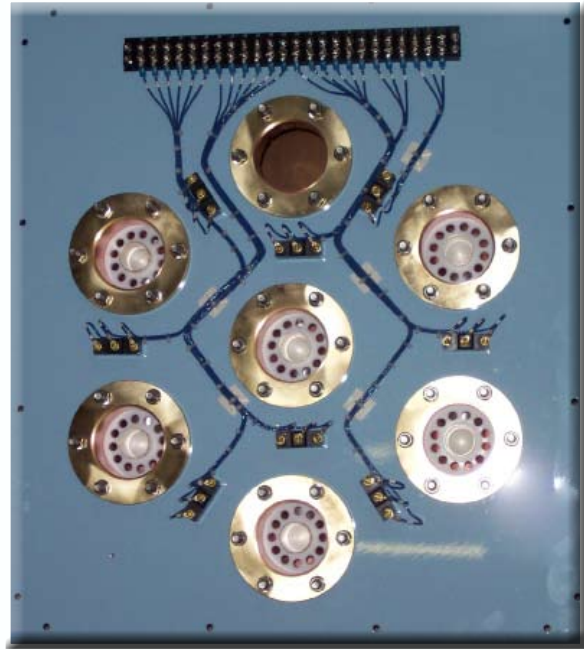

# KINTRONIC LABORATORIES, INC.

## RF PATCH PANEL SERIES FOR AM, FM, AND TV APPLICATIONS

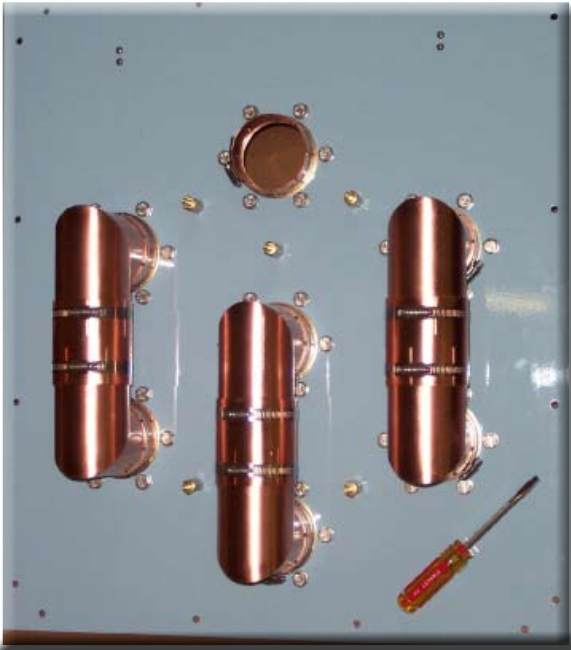

- AVAILABLE IN 7/8" EIA, 1 5/8" EIA, OR 3 1/8" EIA
- INTERLOCK SWITCH FOR EACH U-LINK POSITION WIRED TO TERMINAL STRIP
- EXCLUSIVE TEFLON SUPPORTS FOR U-LINK ELBOW CENTER CONDUCTOR TO ASSURE PROPER U-LINK TO PORT ALIGNMENT
- IMPEDANCE: 50 OHMS

### CUSTOM MATRIX SWITCHING CABINETS

IN ADDITION KINTRONIC LABORATORIES OFFERS CUSTOM MANUAL SWITCH MATRIX CABINETS FOR FM OR TV TRANSMITTING SITES TO PERMIT OPERATION OF MAIN OR STANDBY TRANSMITTERS TO ONE OR MORE ANTENNAS OR DUMMY LOADS

TO COMPLETE THE PATCH PANEL INSTALLATION, KINTRONIC LABORATORIES OFFERS A COMPLETE LINE OF RIGID TRANSMISSION LINES AND ACCESSORIES FOR RF INTERCONNECTIONS BETWEEN PATCH PANELS AND TRANSMITTERS, ANTENNAS AND DUMMY LOADS. CUSTOM STATUS INDICATOR PANELS TO IMPLEMENT INTERLOCK LOGIC ALSO AVAILABLE.



## RF PATCH PANEL SERIES FOR AM, FM, AND TV APPLICATIONS

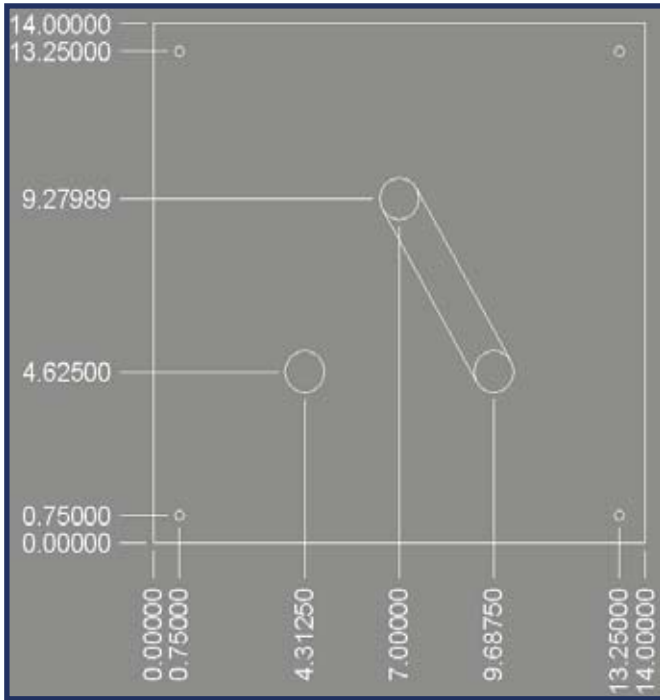

**PP-78- 3U**

3 Port, 1 U-Link, 2 Interlock Positions  
for 7/8" Line

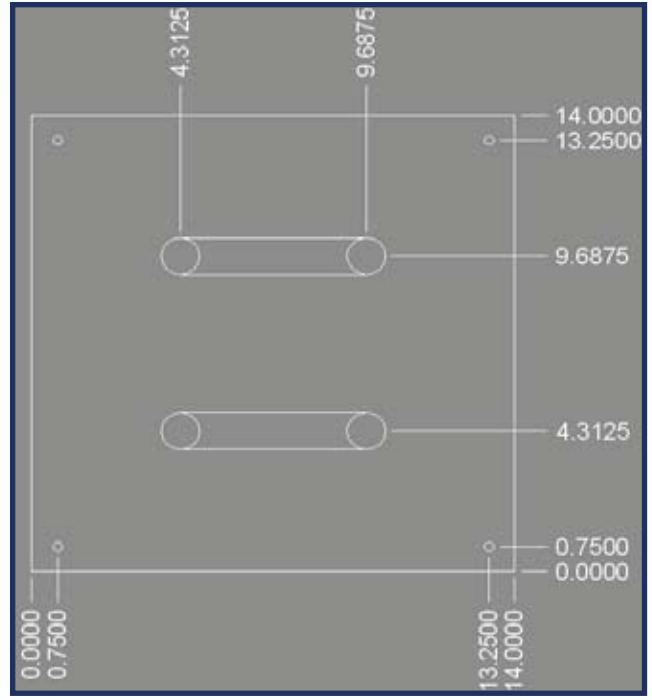

**PP-78- 4U**

3 Port, 2 U-Link, 4 Interlock Positions  
for 7/8" Line

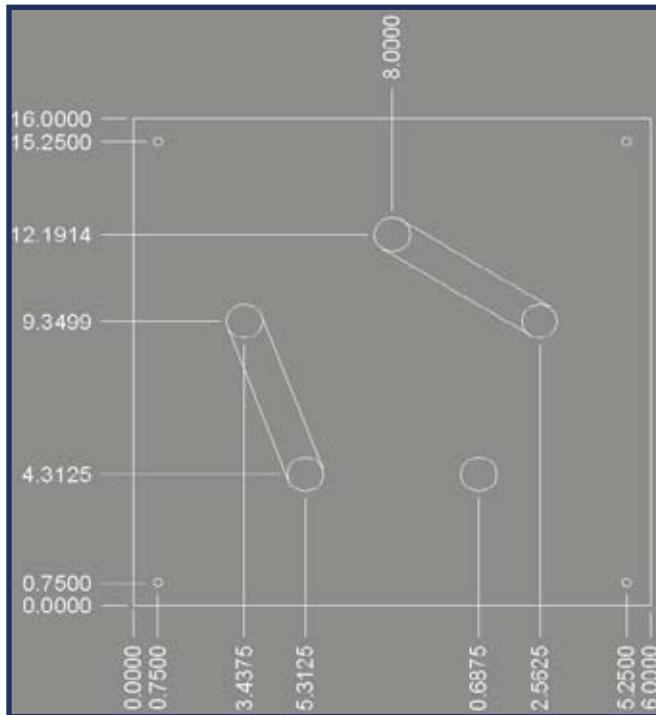

**PP-78- 5U**

3 Port, 2 U-Link, 5 Interlock Positions  
for 7/8" Line

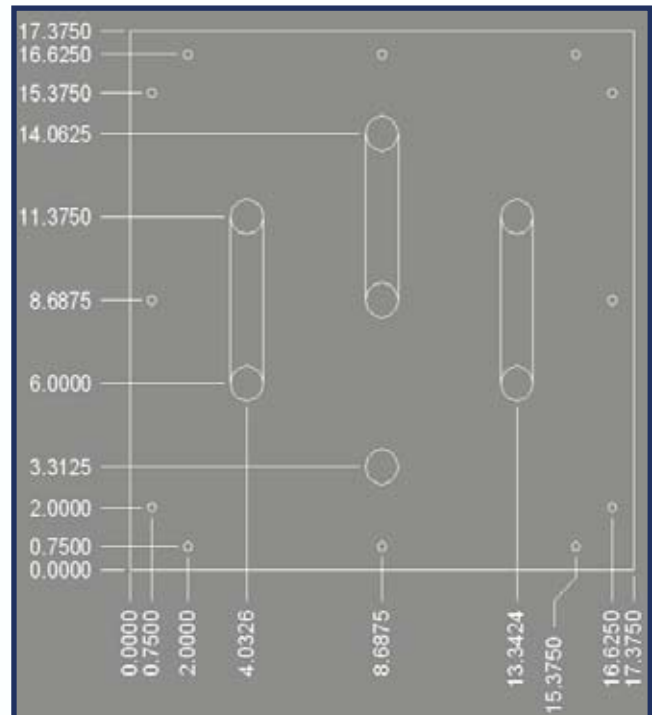

**PP-78- 7U**

3 Port, 3 U-Link, 8 Interlock Positions  
for 7/8" Line

## RF PATCH PANEL SERIES FOR AM, FM, AND TV APPLICATIONS

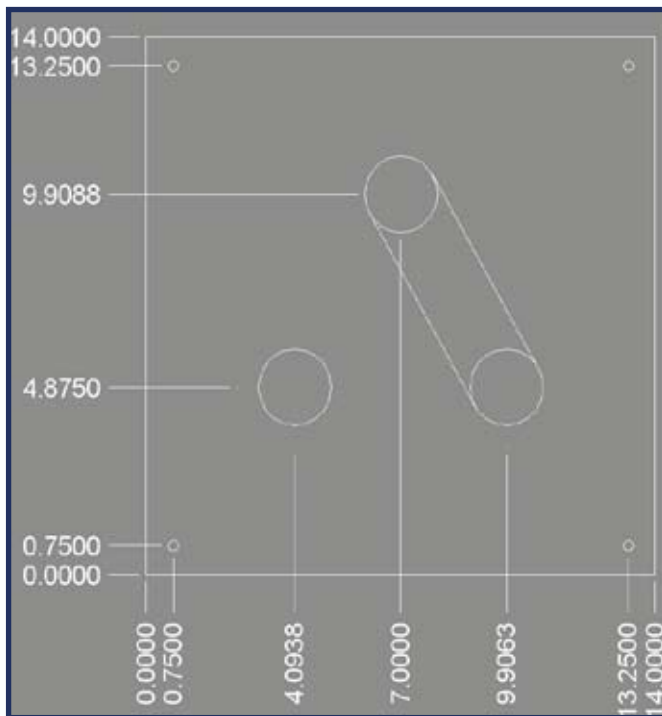

**PP-158- 3U**

3 Port, 1 U-Link, 2 Interlock Positions  
for 1-5/8" Line

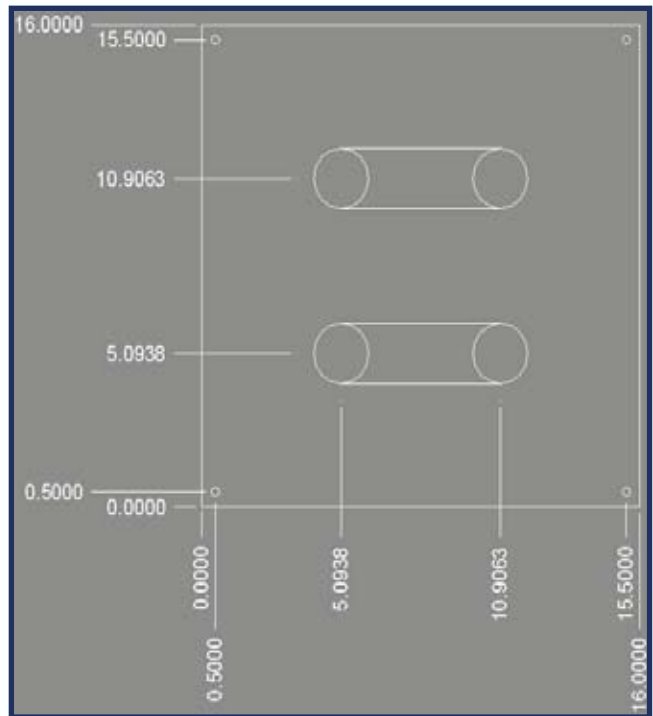

**PP-158- 4U**

3 Port, 2 U-Link, 4 Interlock Positions  
for 1-5/8" Line

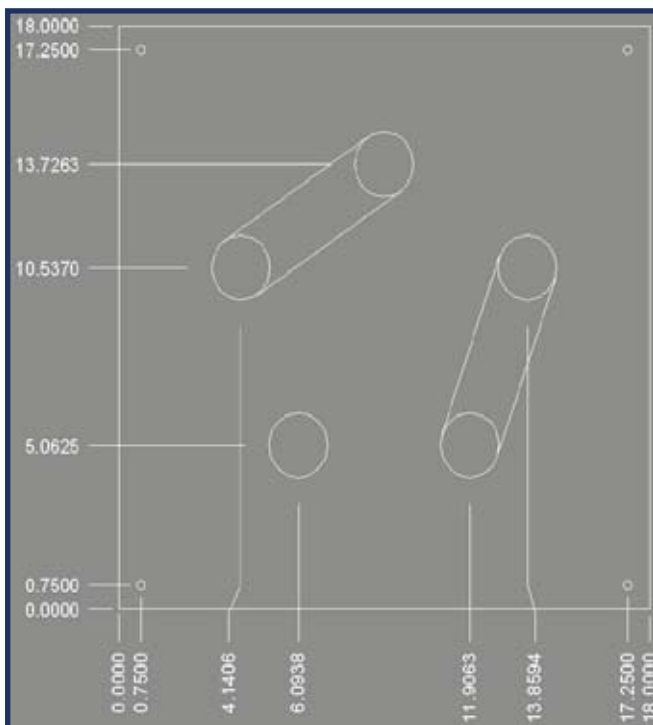

**PP-158- 5U**

3 Port, 2 U-Link, 5 Interlock Positions  
for 1-5/8" Line

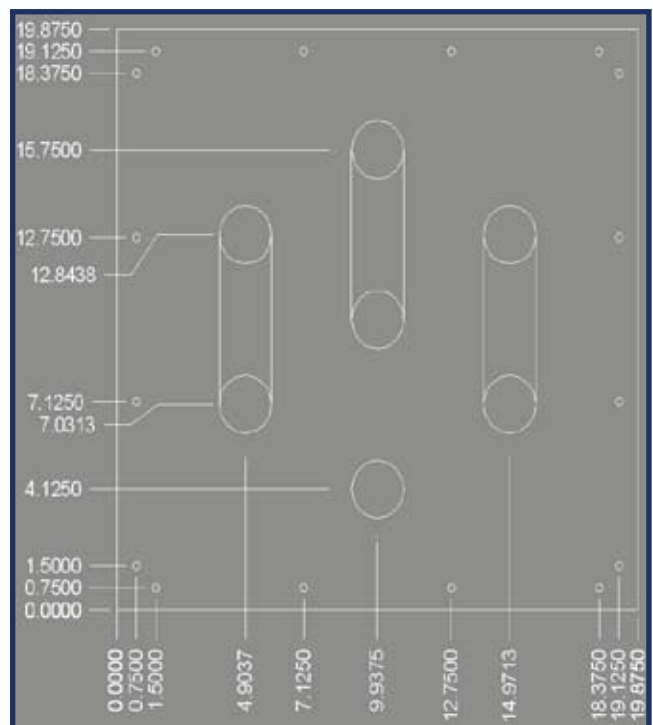

**PP-158- 7U**

3 Port, 3 U-Link, 8 Interlock Positions  
for 1-5/8" Line

# RF PATCH PANEL SERIES FOR AM, FM, AND TV APPLICATIONS

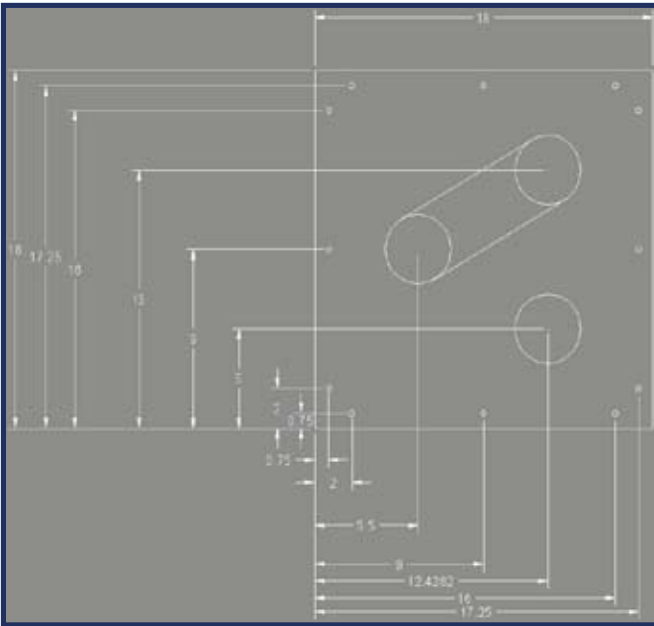

PP-318- 3U

3 Port, 1 U-Link, 2 Interlock Positions  
for 3-1/8" Line

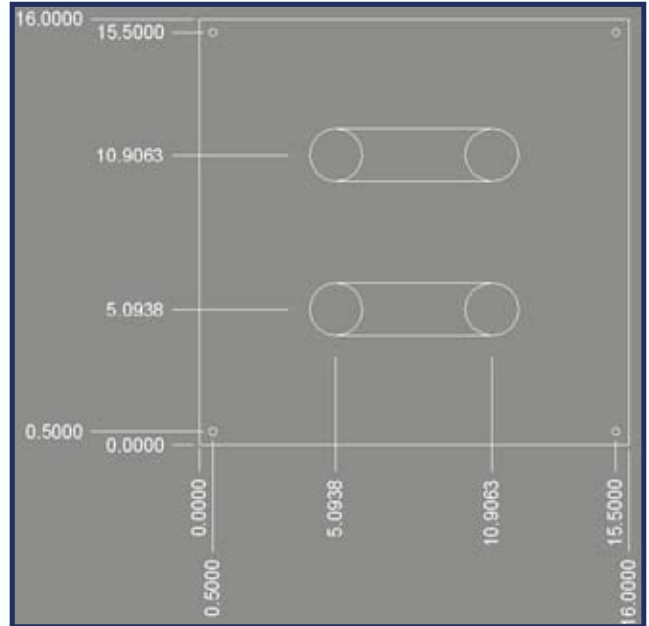

PP-318- 4U

3 Port, 2 U-Link, 4 Interlock Positions  
for 3-1/8" Line

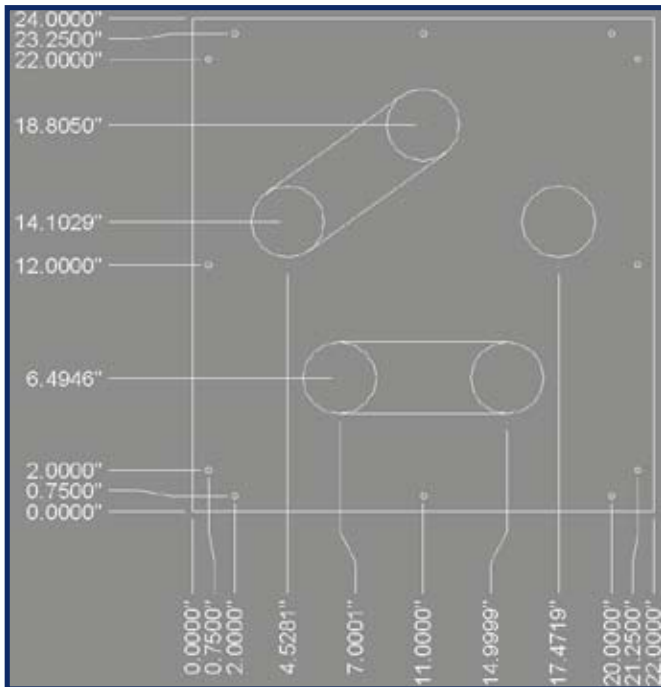

PP-318- 5U

3 Port, 2 U-Link, 5 Interlock Positions  
for 3-1/8" Line

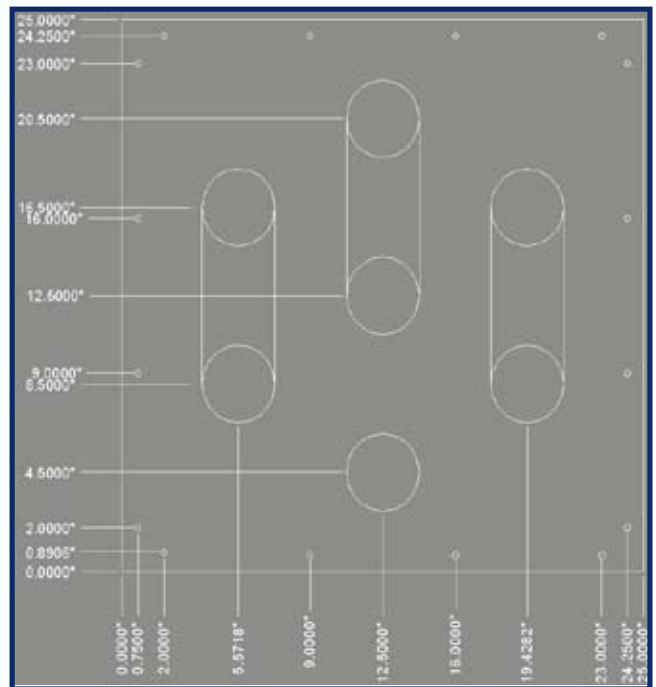

PP-318- 7U

3 Port, 3 U-Link, 8 Interlock Positions  
for 3-1/8" Line

PH: 1-423-878-3141  
FAX: 1-423-878-4224

KINTRONIC LABORATORIES, INC.  
P.O. BOX 845, BRISTOL, TN 37621

www.kintronic.com  
ktl@kintronic.com